



PROTON, as the name suggests has been designed to provide AC power and USB 'fast-charging' in its simplest form.

Designed for panel mounting in furniture, PROTON presents a single or double outlet module in a stylish matt silver, matt black, gloss black or chrome decorative bezel.

PROTON is supplied as a prewired unit with power cable to national mains plug or Wieland connector, ready for installation+.

PROTON can be configured to provide combinations of AC power, USB fast charging and or data as is needed by the user.

All **OE** Electrics products are manufactured to enable compliance with BS6396/BS7671+ where relevant.

USPs

- Designed for panel mounting
- Supplied pre-wired
- Available with TUF charger
- Suitable for many different environments
- BS6396 compliant (where applicable)
- Available with sockets from different nationalities



technical

Common Units

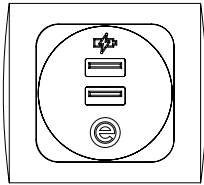

Twin USB Fast charger

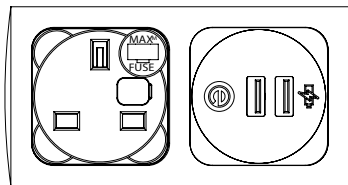

UKF + Twin USB Fast charger

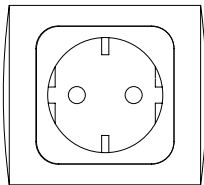

SCH

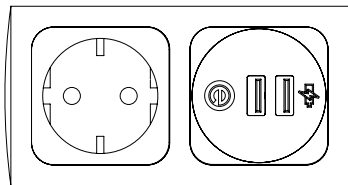

SCH + Twin USB Fast charger

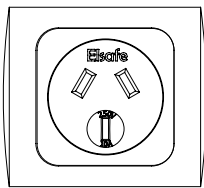

AUS

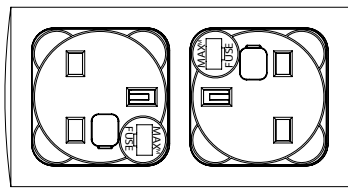

2 x UKF**

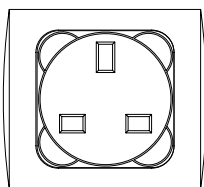

UKU

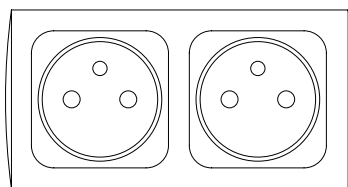

2 x FRB

*see website for more

** UK Fused (UKF) (required for BS6396 compliance) NOT compatible with PROTON single gang
 + PROTON must be fully installed, as per manufacturer's instructions, in order to achieve complete compliance with BS5733 or IEC60884-1. Installation must be completed before PROTON is connected to the supply.

Unit dimensions

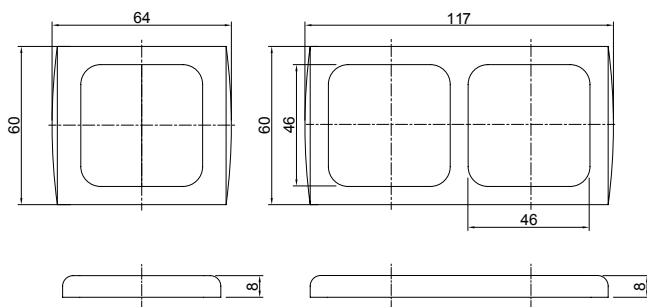

Cutout dimensions

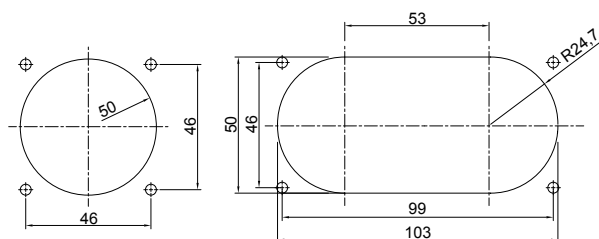

Features

Configuration:

Single outlet units: AC power, USB charging only or data/AV only

Double outlet units: AC power only, USB charging only or data/AV only. Combined AC power, USB charging and/or data/AV

NB: UK fused sockets can only be fitted in double outlet units.

Colours:

Socket fascias: Matt black

Decorative bezels: Matt silver, matt black, gloss black or chrome

Bezel with lid: Matt black

Fusing: To enable compliance to BS6396, UK sockets in double outlets units can be ordered with 3.15 or 5A anti surge ceramic fuses

Testing:

All PROTON units are 100% tested before despatch

Safety approvals:

Sockets are approved to appropriate national and international standards e.g. BS1363, BS5733 and IEC60884-1. The Twin USB fast charger has been certified to IEC60950-1 and UL60950-1.

CE Marking:

All European specification units are CE marked by **OE** Electrics.

Fixings:

PROTON units can be snapped into 16mm panels or screw fixed into any suitable surface.

Shuttered fascia

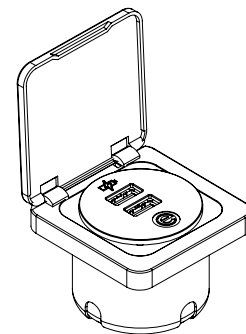

Mounting details

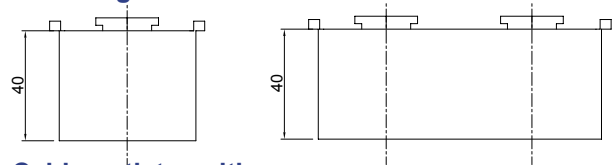

Cable outlet positions

